

## Project processing example (step 1)

Project name: 27GL STORAGE BOX MOLD

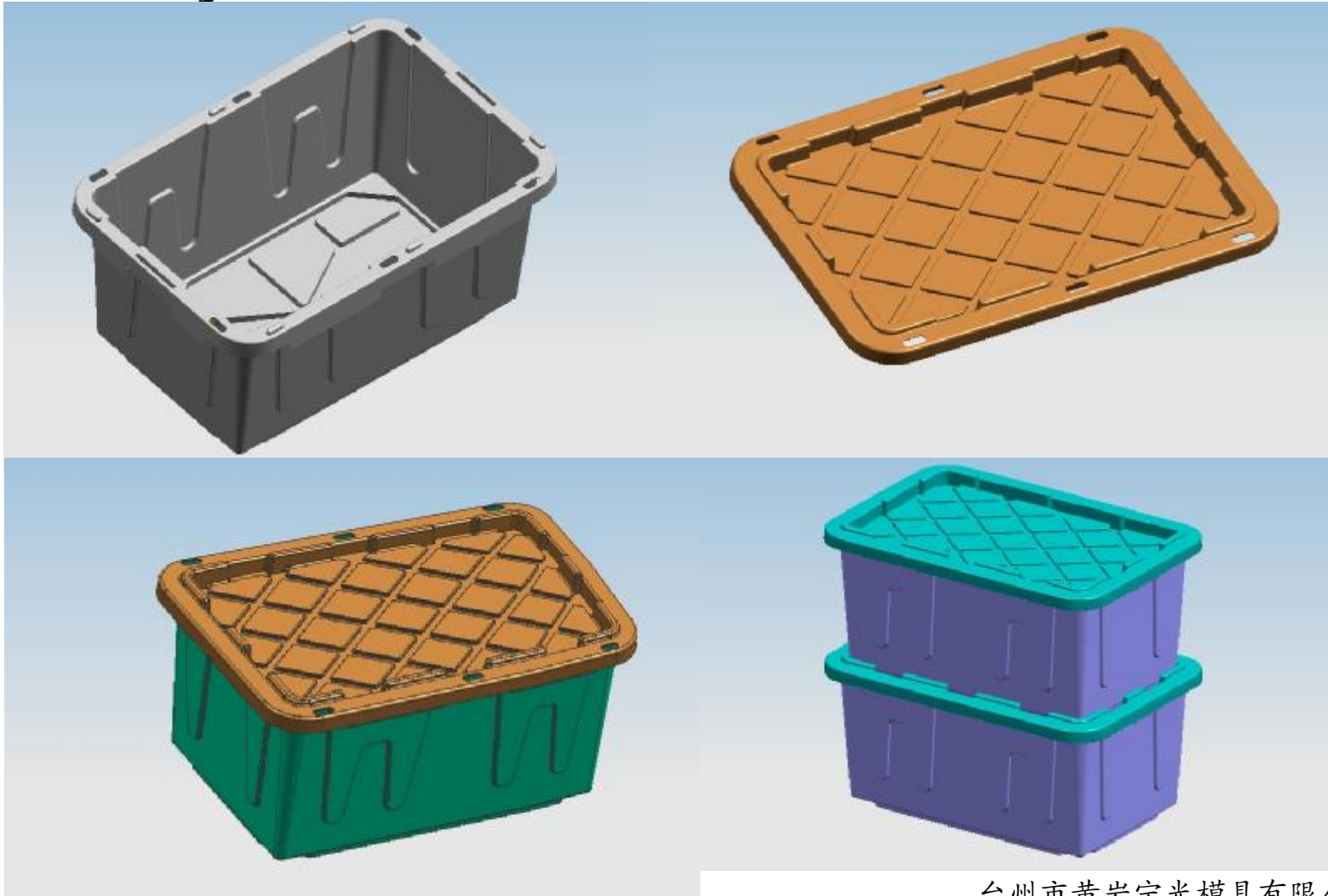



# Project processing example (step 2)

## ✓ Mold flow analysis (27GL base)

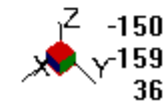
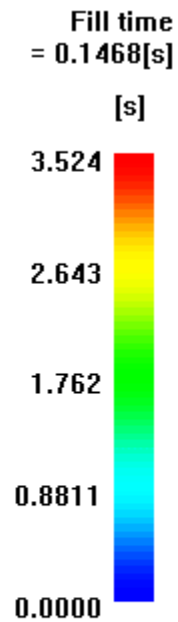
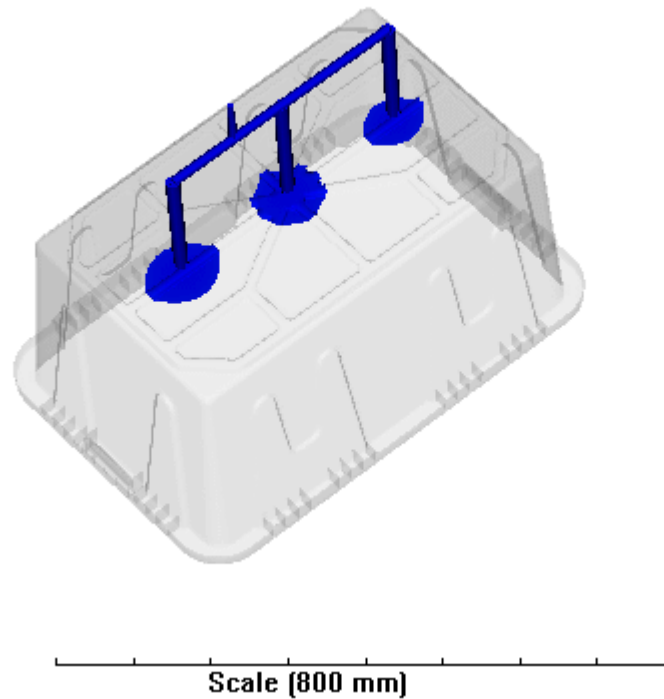



## Project processing example (step 2)

### ✓ Mold flow analysis (27GL lid)

**Moldflow**  
Moldflow Plastic Insight

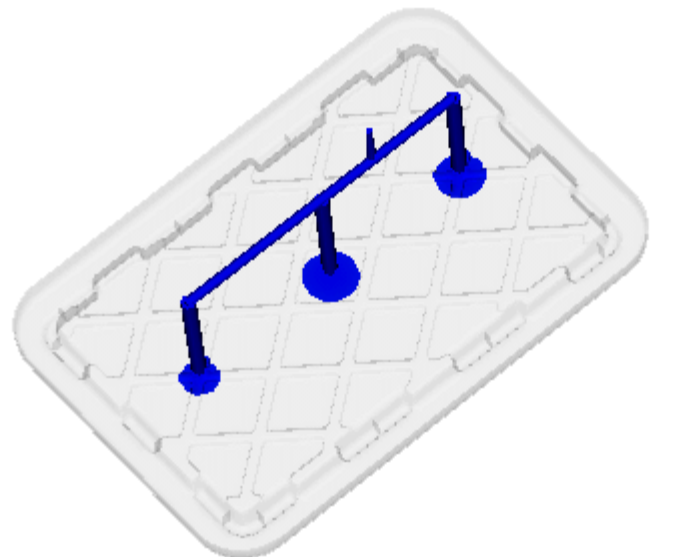

Scale (700 mm)

Fill time  
= 0.1020[s]

[s]

2.448

1.836

1.224

0.6119

0.0000

Y Z X  
-24  
16  
38

## Project processing example (step 3)

### Mold Picture

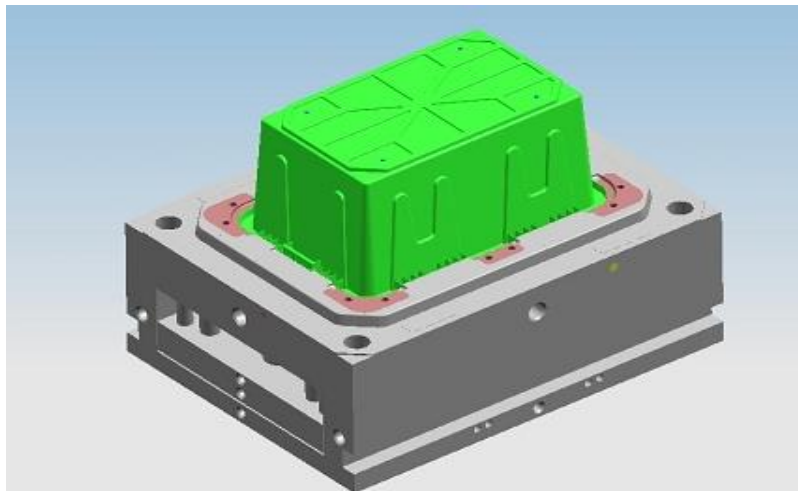
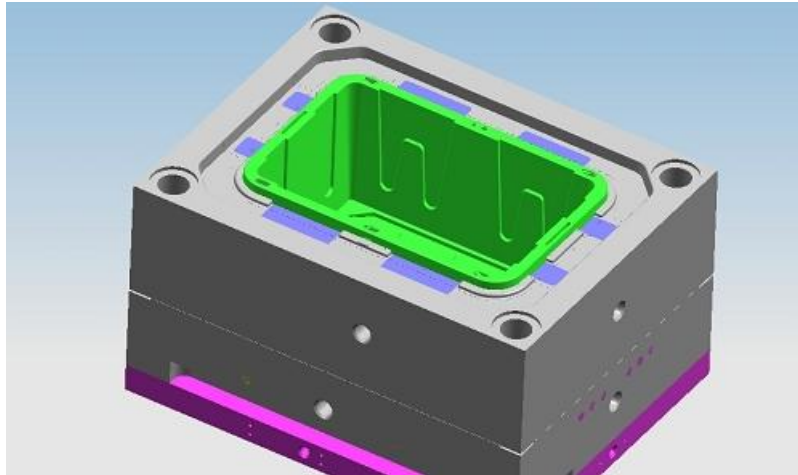

## Project processing example (step 3)

### ✓ Sample picture

